



THE INDUSTRY LEADER

Lock America, Inc., distributed by CDS, has over thirty years of experience producing and delivering highquality security products. On the following pages you will find one of the largest arrays of cam locks, padlocks, specialty locks and security hardware in the world. This catalog contains Lock America's standard hardware and accessories as distributed by CDS. If you don't find what you need, call us toll free. We have many other non-standard pieces in inventory and can custom fabricate for you right in Lock America's southern California facility.

Before ordering, please take a minute to review these guidelines:

Locks:

- Specify type: ✓ Cam Type
- ✓ Padlock

For Keyed Alike Locks:

Specify if you want to maintain an existing key code series or start a new one.

If you want to match locks from another manufacturer, specify the brand and model. Usually we can match Fort, ACE, ESD, Baton and many others.

Hasps:

CDS provides hasps for all Lock America, Inc. Padlocks. Some hasps may require installation modifications. All hasps distributed by CDS will accommodate any size padlock with shackle diameter of 9/16" or less.

See the CDS Catalog for specifics.

Cams:

Please refer to the chart on page 9 for a complete guide to cams in the catalog. If you do not see what you need, call us. We can manufacture a custom piece to your specifications. Minimum quantities may be required for custom orders.

ACCESSORY CATALOG

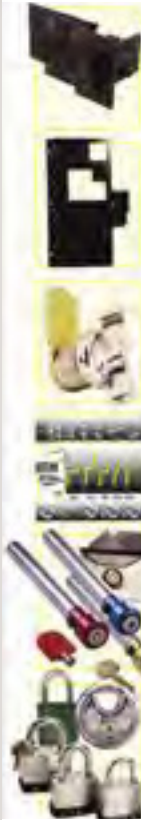

High Security Hasps 1-3

Security Accessories for Amusement and Coin Op..... 4-7

Bulk Vending Locks Economy Camlocks Thumbturns & Keyless Camlocks 8

Cams & Accessories - Ordering Guide. 9

Newspaper Vending Security Locks and Coin Laundry Boxes 10-11

Padlocks 12-13

CDS Endeavors, Inc.

245 N. Euclid Ave
Upland, CA 91786

Tel: 909.920.0390

Tel: 909.437.1558

Fax: 909.920.3560

Toll Free: 866.950.1500

www.ColdDrinkSolutions.com

email: Chris@ColdDrinkSolutions.com

&

Office@ColdDrinkSolutions.com

Lock America's Warranty

L.A.I. Group warrants, to the original purchaser, that all of its locks will be free of manufacturing defects (changes in appearance due to oxidation or normal discoloration excluded) for a period of 7 (seven) years from the date of purchase. L.A.I. Group will not assume any liability for an consequential loss or damages.

ACCESSORY CATALOG



Welded Top Cover to help prevent bending.

Shrouded to protect padlock shackles from bolt cutter attacks.

Center Hole for use with Lock America's "F" model Millennium Locks.

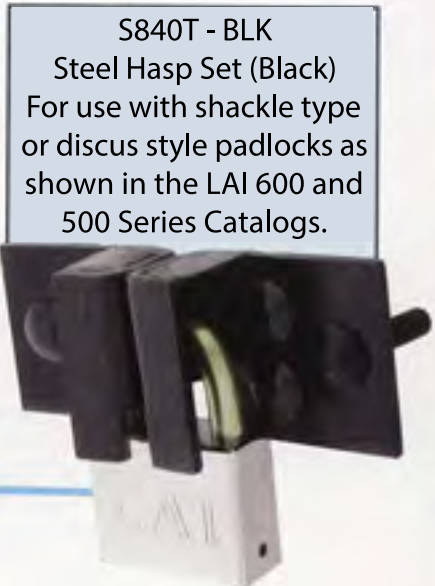

S840T - BLK
Steel Hasp Set (Black)
For use with shackle type or discus style padlocks as shown in the LAI 600 and 500 Series Catalogs.



S820T-A535 - Steel Hasp Set
Set Shown with patented LAI Millennium Lock featured in the LAI 600 Series Catalog.



S828S-21
Hardened Steel Shackle Guard with S820T-A535 Hasp and B645A Padlock Attached

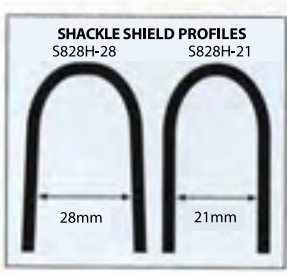
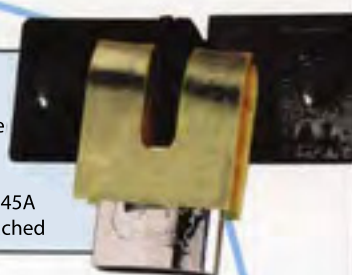

S828S-28
Hardened Steel Shackle Guard



S828S-21
Hardened Steel Shackle Guard



S828S-28
Hardened Steel Shackle Guard with S820T-A535 Hasp and B645A Padlock Attached

Shown with optional carriage bolt cover



S869H - Hasp Set With Shroud Protection and Patented Millennium Lock as seen in the LAI 600 Series Catalog.

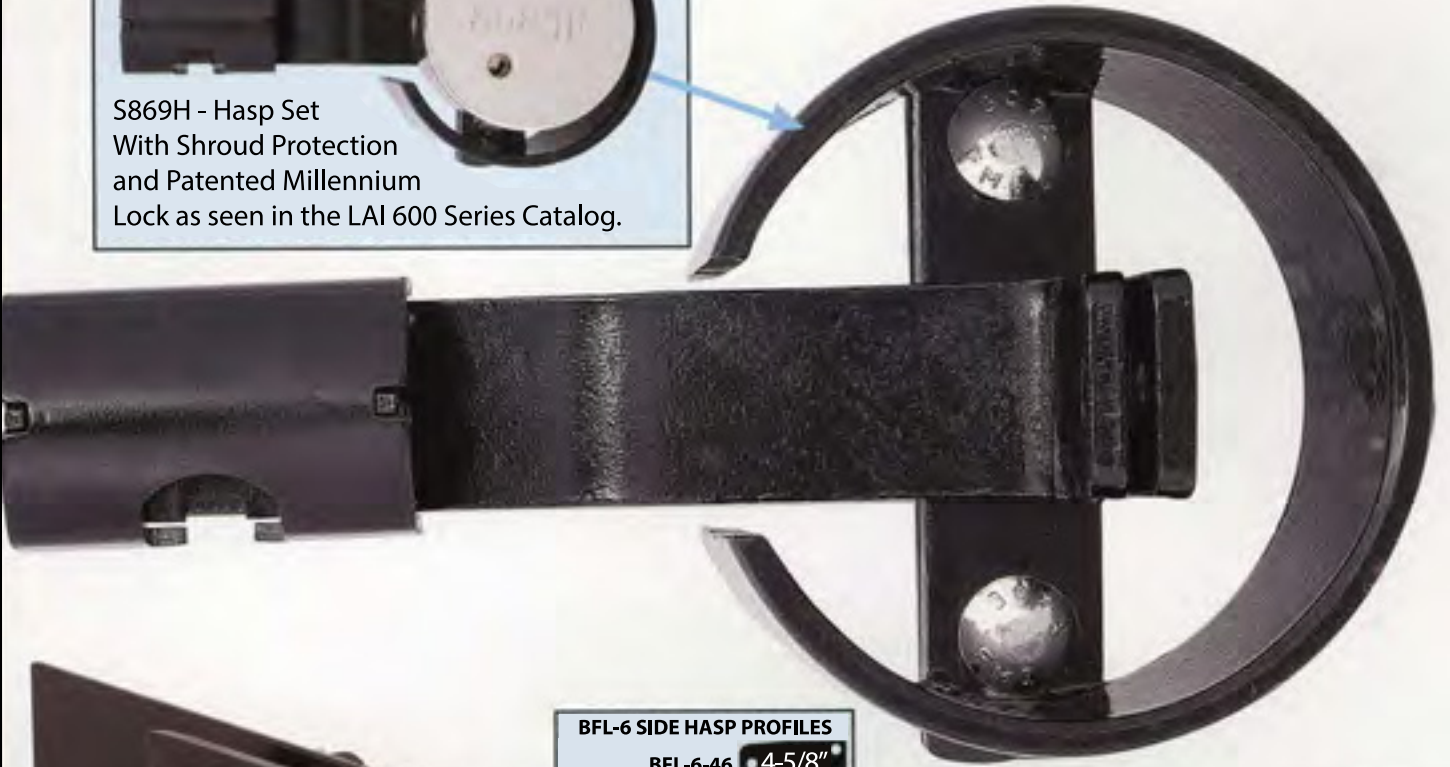

BFL-6 SIDE HASP PROFILES

- BFL-6-46 • 4-5/8"
- BFL-6-46-7 • 7"
- BFL-6-46-13 • 13"

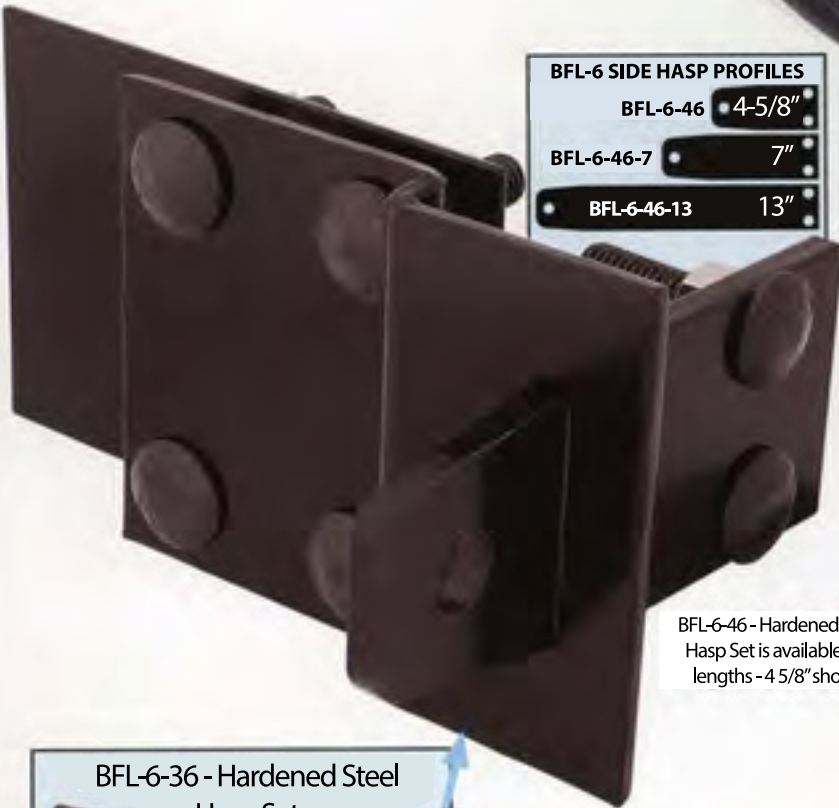

BFL-6-46 - Hardened Steel Hasp Set is available in 3 lengths - 4 5/8" shown



BFL-6-36 - Hardened Steel Hasp Set



Made to be used with "A" Style Locks Only. See 600 Series Lock Catalog.



S820T - Hasp Set (special application) Accommodates Puck Style Locks Featured in the LAI 600 Series Catalog.



Optional Carriage Bolt Cover

S868H-BL - Hasp Set

S868H-BL is designed to fit all Dixie Narco/Royal Vendor/Vendo and other machines.



S868H-MH Mounting Hardware *Sold Separate



S868H-CC** Hardened Steel Hardware Cover *Sold Separate - Designed to be used with all of these LAI Hasps

**Patent Pending - S868H-CC



Different Profiles to Accommodate Most Manufacturers

Please specify machine type

S868R

Universal Fit

S868H

S868D



S868H-PC Hasp Set With Padlock Cover

**Made to use with Shackle style Padlocks



S819N-KS
Security Bar For
Pinball Machines
(Large Door)

Designed to
protect padlocks
from being cut

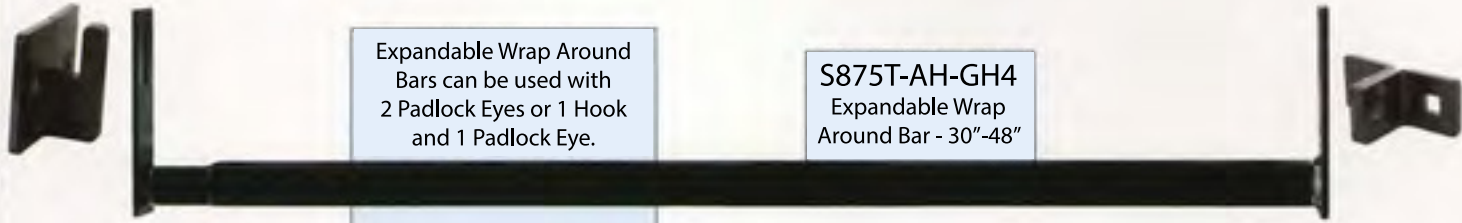

Expandable Wrap Around
Bars can be used with
2 Padlock Eyes or 1 Hook
and 1 Padlock Eye.

S875T-AH-GH4
Expandable Wrap
Around Bar - 30"-48"

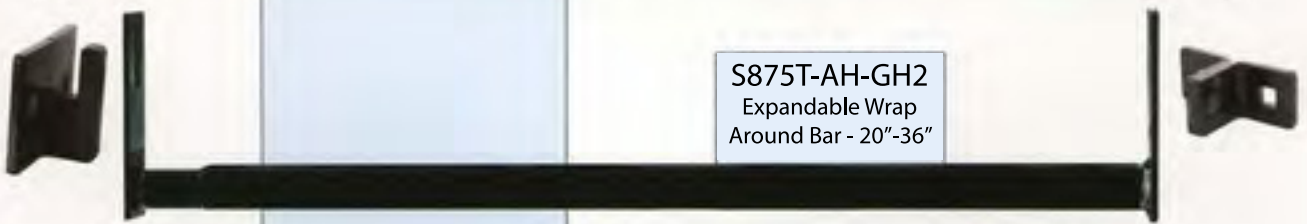

S875T-AH-GH2
Expandable Wrap
Around Bar - 20"-36"

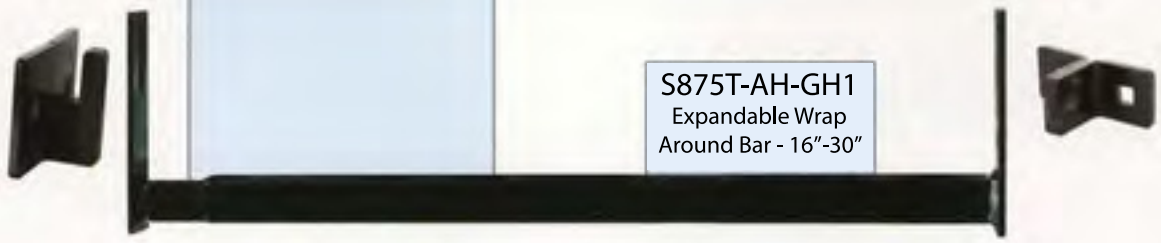

S875T-AH-GH1
Expandable Wrap
Around Bar - 16"-30"

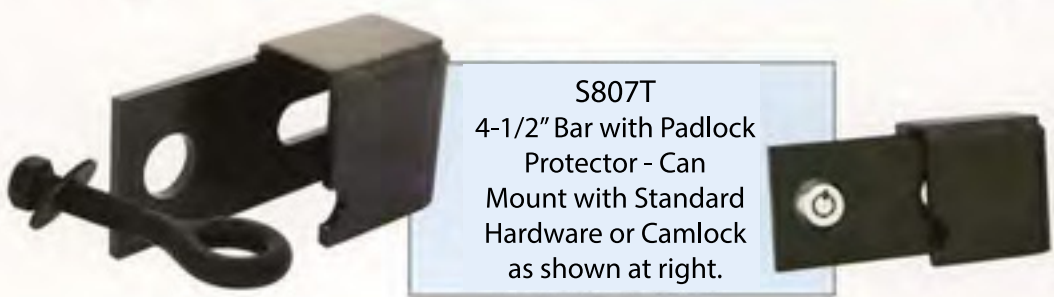

S807T
4-1/2" Bar with Padlock
Protector - Can
Mount with Standard
Hardware or Camlock
as shown at right.



S819H
Original Double
Door Bar



S807T-PGD
Panel Guard
narrow opening



S807T-PGDW
Panel Guard
wide opening



S801T
Standard 12' Bar



S802T
Standard 16' Bar



S803T
Standard 24' Bar



SECURITY ACCESSORIES FOR AMUSEMENT AND COIN OP



Designed for use with padlocks and shrouded to prevent cutting.

Welded to prevent bending.

S819X-BV
Full Metal Jacket
With Cutout For
Bill Validator



Pre-Threaded Backing Plate included

S819X
Full Metal Jacket Ultimate
Double Door Bar
(Shown with optional B645B
Padlock featured in the
LAI 600 Series Catalog.)

Pre-Threaded Backing Plate included



Pre-Threaded
Backing Plate
included



S819X-2000

Full Metal Jacket Ultimate Double Door Bar Designed to Accommodate Puck style locks. Shown with Millennium Lock as soon in the LAI Series 600 Catalog.



Z427G-A0
Original Style Bulk Vending Lock



Z428P-OH
Housing for use with Z427, B527G and Z437 bulk vending locks



Z437N-A0
NEW Slotted Dimple Key Bulk Vending Lock with Two Rails - Standard Design



Z437G-A0
Original Style Dimple Key Bulk Vending Lock with Two rails - Standard Design



Z431N-A0
NEW - Slotted Dimple Key Bulk Vending Lock with Larger Diameter Four Rail Design for Special Machine applications.



Cut Dimple Key
Z437G-CK for Z437G Lock
Z413N-CK for Z413N Lock



Z427G-CK
Cut Key for Z427G Lock



B527G
Tubular Style Drop-In Lock for Bulk Vending Machines with Two Rails Standard Design



Z122G - 7/8" - (22mm)
Thumbturn Camlock



Not shown
Z122G-RI-7/8" (22mm)
Slotted Front Camlock

Z431G-A0
Original Style Dimple Key Bulk Vending Lock with Larger Diameter Four Rail Design for Special Machine applications.

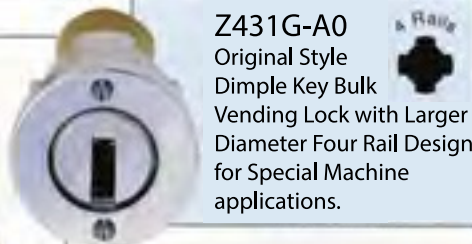

400 Series
Economy Camlock and Cut Keys



Z400D-CK
Cut Keys for all 400 series camlocks



Z118G - 5/8" - (18mm)
Thumbturn Camlock
Z118S-RT - 5/8" (18mm)
Thumbturn Camlock with Standard Tail Piece



Not Shown
Z118S - 5/8" - (18mm)
Slotted Front Camlock with Standard Tail Piece - Special Order
Z118G-RI - 5/8" (18mm) Slotted Front Camlock with Standard Tail Piece - Special Order

Z418D-AI-D2 - 5/8" - (18mm)
Economy Camlock - Available Keyed Alike or Keyed Different - Side View Comes with Standard Tail Piece.



Z422D-AI-D2 - 7/8" - (22mm)
Economy Camlock Available Keyed Alike or Keyed Different - Side View Comes with Standard Tail Piece.



Z430D-AI-D2 - 1-1/8" - (30mm)
Economy Camlock Available Keyed Alike or Keyed Different - Side View Comes with Standard Tail Piece.



Z130G - 1-1/8" - (30mm)
Thumbturn Camlock
Z130G-RT - 1-1/8" (30mm)
Thumbturn Camlock with T-Shaped Handle
Z130S-RT - 1-1/8" - (30mm)
Thumbturn Camlock with Standard Tail Piece



All of the Thumbturns and Z400 Camlocks shown on this page come with Standard Tail Pieces and can be used with Standard Cams.

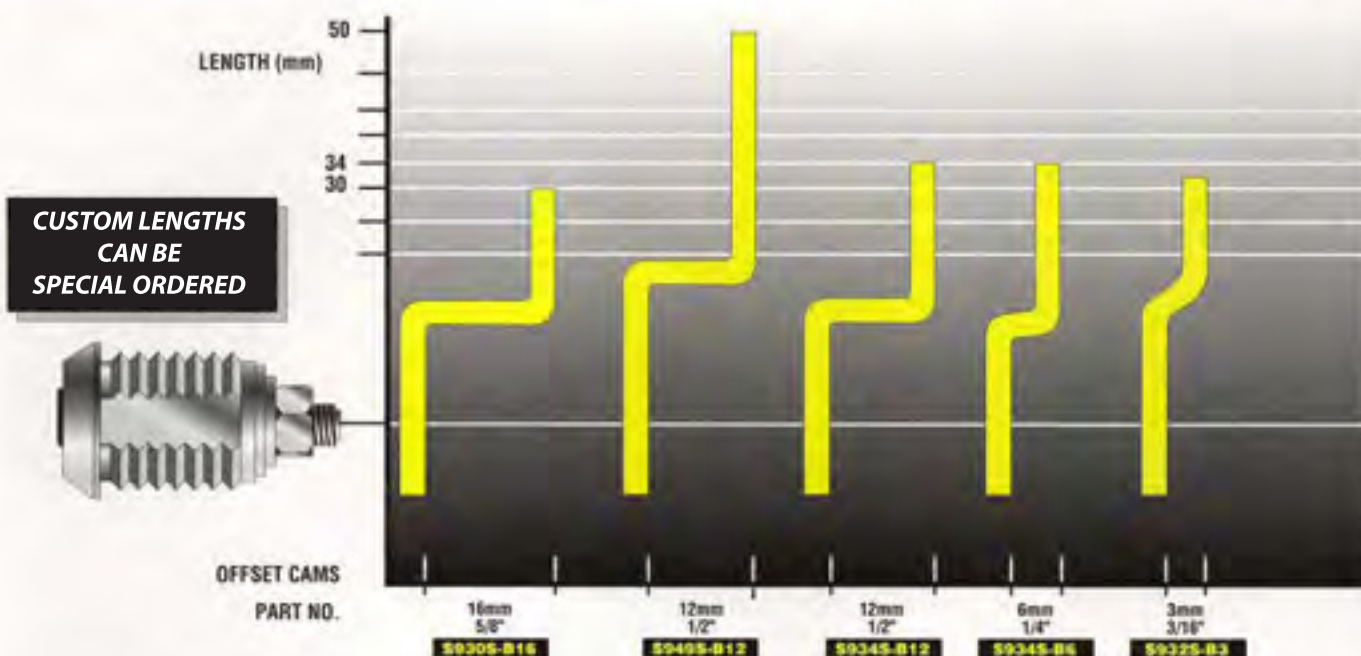

PART NO.	OUTER DIAMETER	INNER DIAMETER	HEIGHT	FLATS	MATERIAL	FINISH
S8215	1-1/8"	3/4"	1/8"	2	Steel	Nickel
S8235	1-1/16"	3/4"	1/8"	0	Steel	Nickel
S8245	7/8"	3/4"	1/8"	0	Steel	Nickel
S8225	1-1/8"	3/4"	1-1/16"	2	Steel	Nickel
S8255-H5	1-3/16"	3/4"	1/4"	0	Hardened Steel	Chrome
S8265	1-3/16"	3/4"	3/8"	0	Brass	Chrome

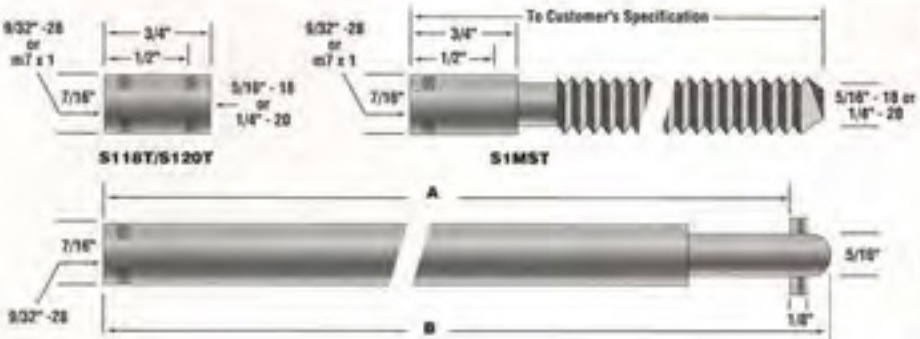

PART NO.	"A" DIMENSION	"B" DIMENSION
S112T	4-3/4"	5"
S121T	8-3/16"	8-7/16"
S130T	11-1/2"	11-5/8"
(See Insert)	12-5/16"	13-5/8"

Shaft can be used for both lengths.



NEW
DOUBLE LOCKING

Extended Length allows You To Double Lock

A626L
High Security Bolt Lock
Shown with Optional Hardened
Steel Security Collar
Available in Blue, Gold or Raspberry

B645B
High Security Padlock
with Boron Alloy
Shackle - featured in the
600 Series Catalog

High Security Bolt Lock also
available in 500 Series Tubular Lock

S836H

A526F
Original Raspberry
Bolt Lock with
500 Series Tubular Key
Lock - Also Available in
Gold and Blue

A626F
Original Blue
High Security
Bolt Lock - Also
Available in
Raspberry

N613K
600 Series
High
Security Key

S502K
Tubular Keys
Available with Color
Keybows as Shown Below

**Color
Keybows**
Color keybows
allow for fast
and easy
identification of
N613K keys.

A626F
Original Gold - High
Security Bolt Lock

**Color
Keybows**
Color keybows
allow for fast and
easy identification
of S502K
keys.

S102V
Oversized Coin
Laundry Box
7.0" Long
3.5" Wide
3.24" Deep



S100V
Standard Coin
Laundry Box
5.75" Long
3.5" Wide
2.5" Deep



All coin vaults available with your choice of either High-Security LAI 600 Series Locks or the LAI 500 Series Tubular Locks.

S112T with B518G
4-3/4" - 90° Turn Shaft - Shown with
Optional Tubular Camlock Available in
the LAI 500 Series Catalog.



- S112T 4-3/4" - 90° Turn Shaft
- S121T 8.16" - 90° Turn Shaft
- S125T 10" - 90° Turn Shaft
- S129T 11.63" - 90° Turn Shaft
- S131T 12-1/4" - 90° Turn Shaft

S112T with B618B
4-3/4" - 90° Turn Shaft - Shown with
Optional High-Security Camlock
Available in the LAI 600 Series Catalog.



Custom length shafts available - Tell us your requirements



Camlock Screwshafts
Made to Customer's
Speciycation's - Please Refer
to Page 9 for Assistance.



(Meets NAMA speciycations)
**Shaft is sold separately
please specify length

C865H-090
C832H-090
Quarter Turn T-Handle
available in Two sizes
with a black or chrome
ynish - See Series 500 and
600 catalogs for all
options.

T-Handle Threaded Screw Shafts
For use with T-Handles

- A. C865H-T056 - 2-1/4" - 56mm
- B. C865H-T070 - 2-3/4" - 70mm
for use with quarter turn only
- C. C865H-T069 - 2-11/16" - 69mm
- D. C865H-T104 - 4 - 5/32" - 104mm
- E. C865H - T124 - 4-7/8" - 124mm
- F. C865H-T164 - 6-17/16" - 164mm

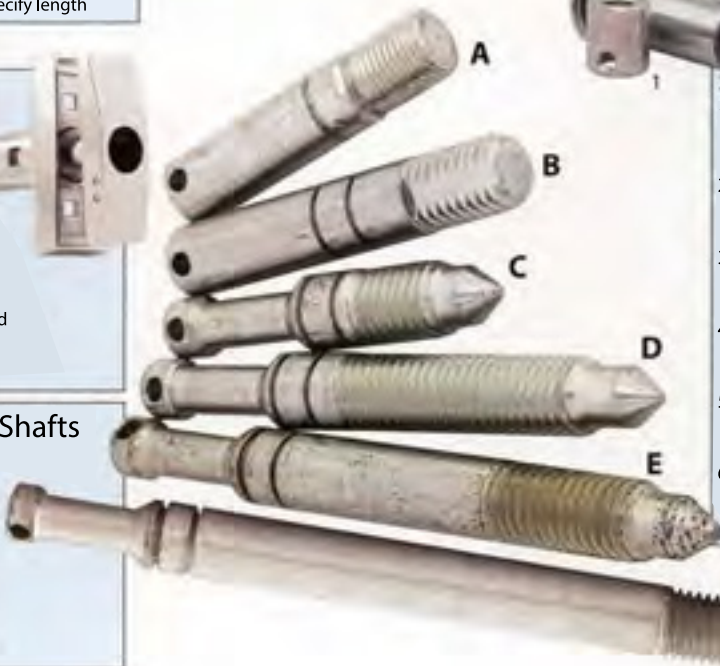

Screwshaft Couplers

- | | |
|-----------------|--|
| 1. S120T | 13MM Long
6MM Inner Dia.
14x20 Inner Thread |
| 2. S120T-3/4" | 19MM Long
6MM Inner Dia.
14 x 20 Inner Thread |
| 3. S118T-600 | 20MM Long
7MM Inner Dia.
9/32" Inner Thread |
| 4. S118T-700 | 20MM Long
7MM Inner Dia.
M7 x 5/16" Inner Thread |
| 5. S120T-13/16" | 21MM Long
6 MM Inner Dia.
14 x 20 Inner Thread |
| 6. S120T-1-1/4" | 32MM Long
6MM Inner Dia
14 x 20 Inner Thread |



A740N-A0-Color
 1-5/8" - 40mm
 Easily Re-Keyable Zimag
 Padlocks with Chrome
 Shackles

**COMING
 SOON**
**50mm
 Size**



A740N-IC-Inner Core
 Assembled in California. Can
 be assembled to the B745C
 Key Codes and some other
 companies key codes.



B745C-CK - Cut Key



B435B-AI
 Solid Brass Bodies
 and Chrome Plated
 Brass Shackles O'er
 the Ultimate in Rust
 Prevention - All yve
 colors are keyed alike.

S780R - AI-RED
 Diameter:
 3-1/8"
 (80mm)



Super Yellow, Big Red Green Monster and Big Blue - Heavy Duty,
 keyed alike, disk locks.
 All four colors
 keyed alike
 Diameter:
 2-3/4"
 (y0mm)



**S770R - AI
 Color**

B750X-A1 - 50mm
B745C-A1 - 45mm
Solid Brass Padlocks



- Hardened steel shackles.
- Solid brass body for maximum rust resistance.
- Double locking heel and toe latch mechanism.
- Hundreds of keyed-alike systems available.
- B745C Can be keyed alike to A740c padlocks.
- Yale security keyway.
- Red warning label permanently stamped onto body.
- May be keyable to some other manufacturer's locks.

S770R-DK6-KA

Diameter:2-3/4"(70mm)
 Dimple Key, Keyed Alike
 Disk Lock - dimples resist sticking and breaking.

These disk locks feature Stainless Steel Bodies to resist rust and Hardened Shackles for added security



S770R-A1

Diameter:2-3/4"(70mm)

L750J-A1
L745J-A1
L740J-A1
L730J-A1
 Laminated Steel Padlocks



- Hardened steel shackles.
- Zinc-plated laminated steel body to resist rust
- Double locking heel and toe latch mechanism.
- Many keyed-alike systems available.
- The three largest sizes can be keyed to the same combination and also to some other manufacturers' key codes.
- Different sizes may be keyed alike.
- Variety of security keyways available.



B440D-AI - 40mm
B430D-AI - 30mm
 Solid Brass Economy Keyed Alike Padlocks

- WARNING permanently stamped into 40mm padlock
- Hardened steel shackle.
- Solid brass body.



B425D-AI - 25mm
 Solid Brass Economy Keyed Alike Padlocks

- Hardened steel shackle.
- Solid brass body.