



# SERIES 500 CATALOG

# SERIES 500 CATALOG

## THE INDUSTRY LEADER

Lock America, Inc., distributed by CDS, has over thirty years of experience producing and delivering high quality security products. On the following pages you will find one of the largest arrays of cam locks, padlocks, specialty locks and security hardware in the world. This catalog contains Lock America's standard hardware and accessories as distributed by CDS. If you don't find what you need, call us toll free. We have many other non-standard pieces in inventory and can custom fabricate for you right in Lock America's southern California facility.

*Before ordering, please take a minute to review these guidelines.*

### Locks:

- Specify type:    ✓ Cam Type,
- ✓ T-Handle, or
- ✓ Padlock

### For Keyed Alike Locks:

Specify if you want to maintain an existing key code series or start a new one.

If you want to match locks from another manufacturer, specify the brand and model. Usually we can match Fort, ACE, ESD, Baton and many others.

### Hasps:

We provide hasps for all L.A.I. Padlocks. Some hasps may require some minor installation modifications. All L.A.I. hasps will accommodate any size padlock with shackle diameter of 9/16" or less.

See the CDS catalog for specifics.

### Cams:

Please refer to the chart on page 9 for a complete guide to cams in the catalog. If you do not see what you need, call us. We can manufacture a custom piece to your specifications. Minimum quantities may be required for custom orders.



- Key Profiles & Dimensional Information ..... 1
- Camlocks, T-Handle Cylinders and Bulk Vending Locks..... 2
- Disk Locks and Padlocks ..... 3
- Switch Locks & Resetttable Locks ..... 4
- T-Handle Locks..... 5
- Hasps..... 6
- Cams & Accessories..... 9

**CDS Endeavors, Inc.**  
 245 N. Euclid Ave  
 Upland, CA 91786  
 Tel: 909.920.0390  
 Tel: 909.437.1558  
 Fax: 909.920.3560  
 Toll Free: 866.950.1500

www.ColdDrinkSolutions.com  
 email: Chris@ColdDrinkSolutions.com  
 &  
 Office@ColdDrinkSolutions.com

*Lock America's Warranty*

*L.A.I. Group warrants, to the original purchaser, that all of its locks will be free of manufacturing defects (changes in appearance due to oxidation or normal discoloration excluded) for a period of 7 (seven) years from the date of purchase. L.A.I. Group will not assume any liability for consequential loss or damages.*

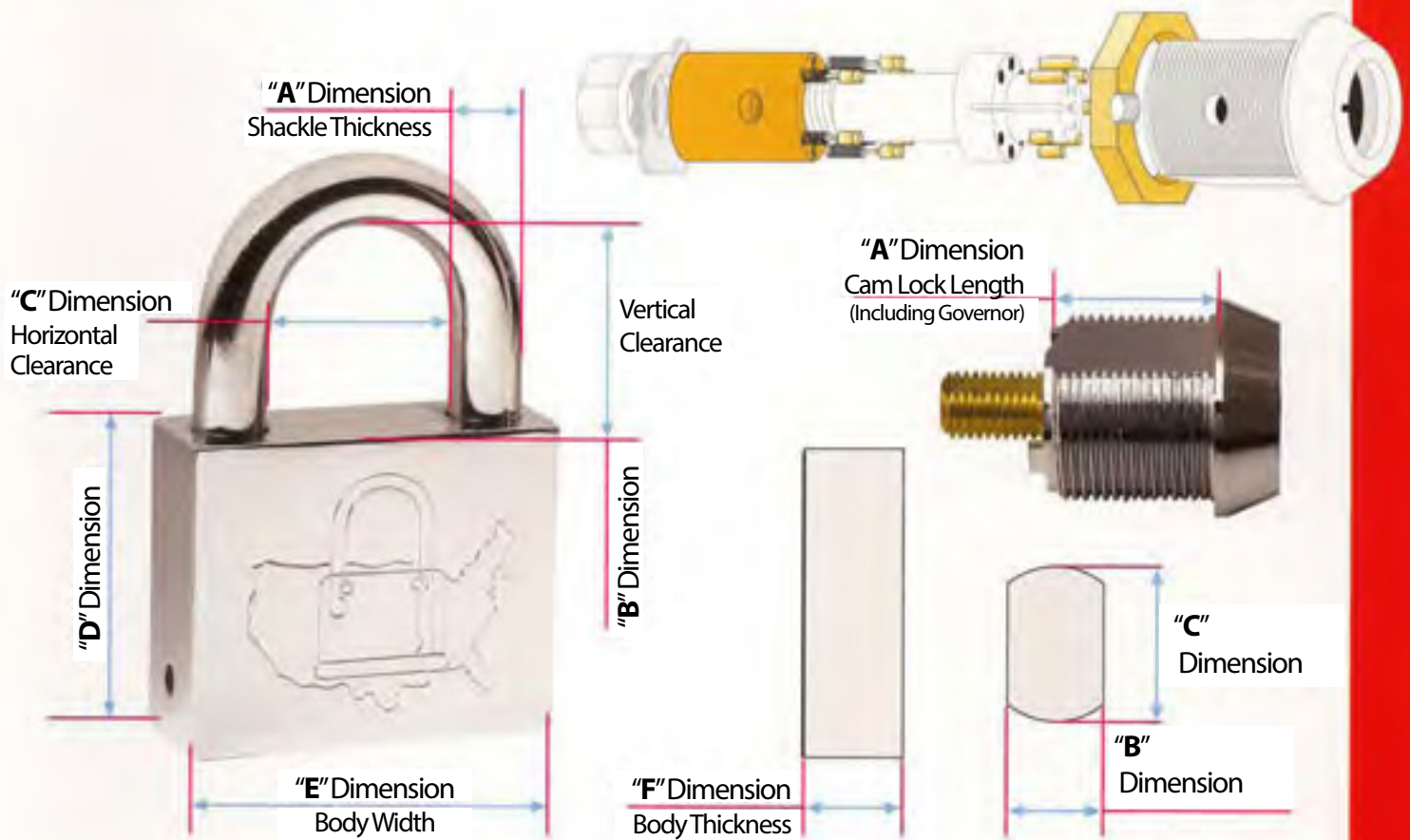
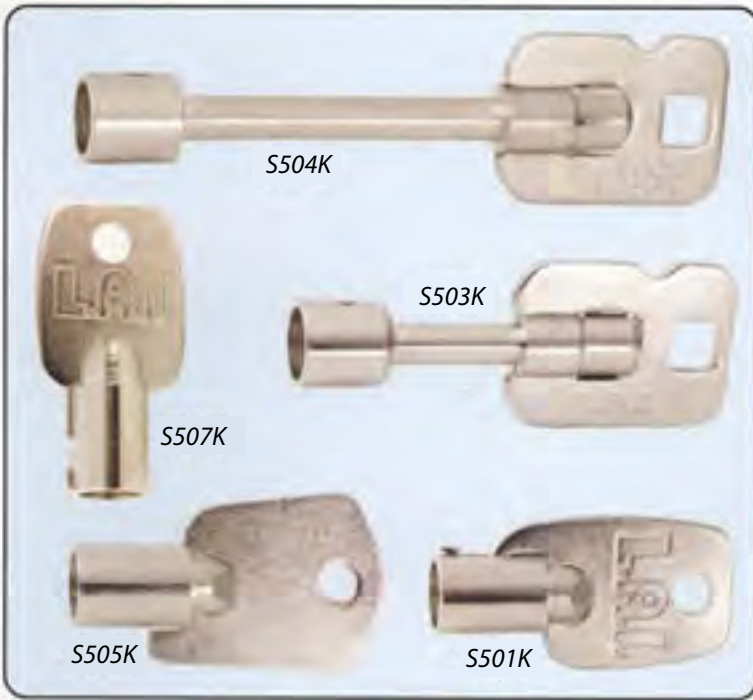





**1/2" (12 mm)**  
Camlock  
Only Available in Screw Type  
Short Vending Bolt



**B512G**  
Two Key Pulls  
12 - 3  
Turns 360° Only



**1/2" (13 mm)**  
Camlock



**B513G**  
Two Key Pulls  
12 - 3  
Turns 90° Right



**1-1/8" (30mm)**  
Camlock



**B530G**  
One Key Pull  
Turns 1/4, 1/2, 360°  
Right or Left



**5/8" (13 mm)**  
Camlock



**B518B**  
Camlock with Ball Bearing - One Key Pull  
Turns 1/4, 1/2, 360°  
Right or Left



**B518E**  
Two Key Pulls  
12 - 6  
Turns 1/2 & 360°  
Right or Left



**B518F**  
Two Key Pulls  
12 - 3  
Turns 1/4 Right



**B518G**  
One Key Pull  
Turns 1/4, & 1/2  
Right or Left



**B518K**  
Three Key Pulls  
9 - 12 - 3  
Turns 1/4 Right or Left



**B518L**  
Two Key Pulls  
12 - 9  
Turns 1/4 Left



**7/8" (22 mm)**  
Camlock



**B522F**  
Two Key Pulls  
12 - 3  
Turns 1/4 Right



**B522G**  
One Key Pull  
Turns 1/4, 1/2,  
360° Right or Left



**B522K**  
Three Key Pulls  
9 - 12 - 3  
Turns 1/4 Right or Left



**B519H**  
Tubular Style Plug Lock - T-Handle  
Cylinder (Meets N.A.M.A. Standards)



**B527G**  
Tubular Style Drop-In Lock for Bulk Vending Machines

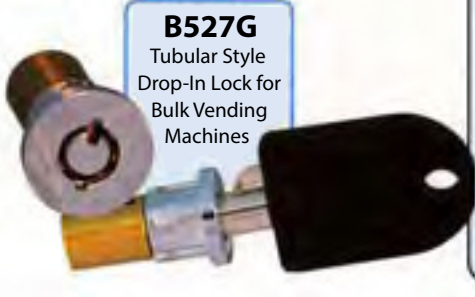

**B530F**  
Two Key Pulls  
12 - 3  
Turns 1/4 Right



**1-1/2" (40mm)**  
Camlock



**B540F**  
Two Key Pulls  
12 - 3  
Turns 1/4 Right



**B540G**  
One Key Pull  
Turns 1/4, 1/2,  
360° Right or Left



**What is a 12-3 Key Pull?**  
A "Key Pull" is an exit for a key at a certain position on the lock face. The location of the "Key Pull" is typically labeled according to the numbers on a clock.



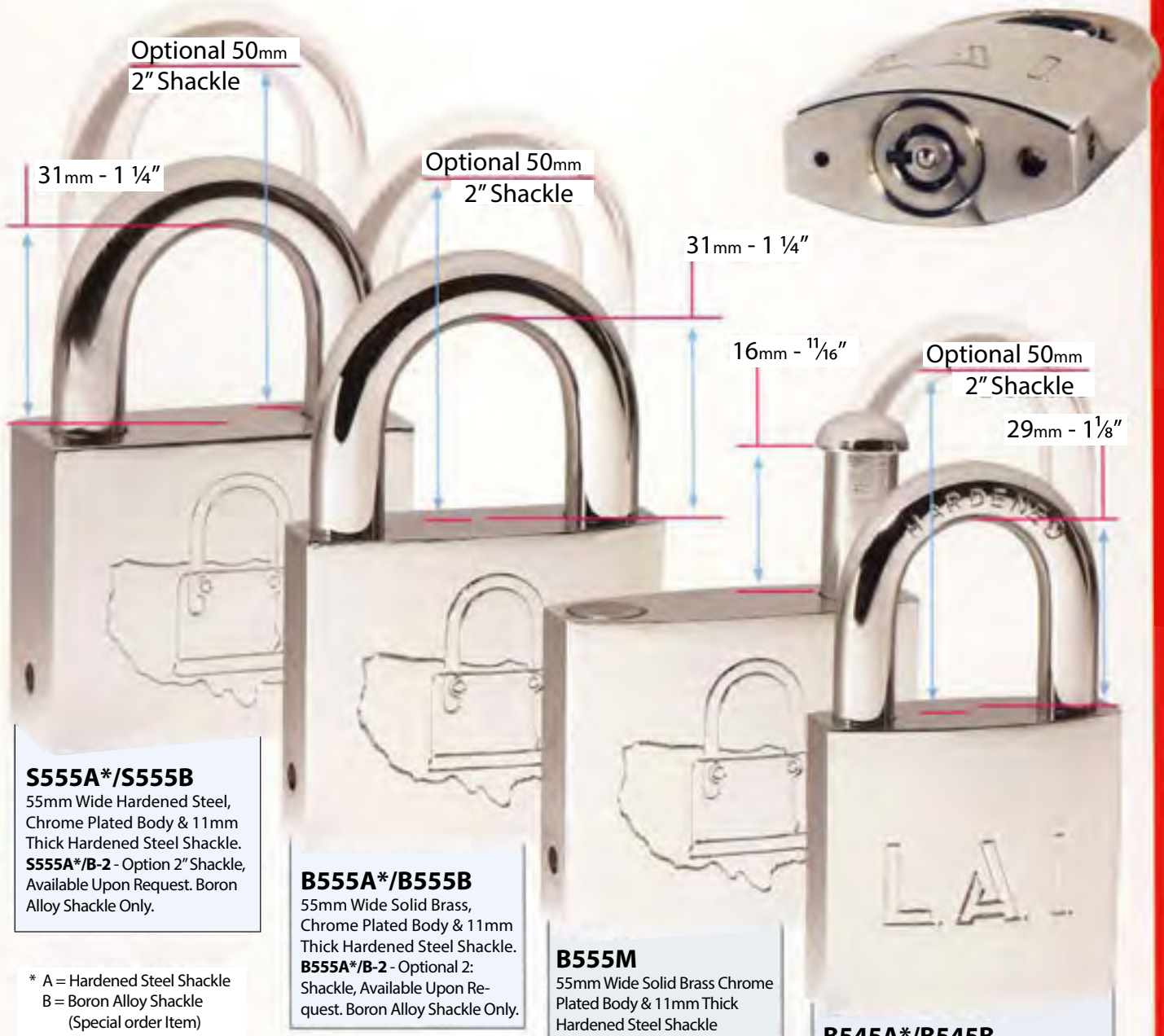

**S555A\*/S555B**  
55mm Wide Hardened Steel, Chrome Plated Body & 11mm Thick Hardened Steel Shackle. **S555A\*/B-2** - Option 2" Shackle, Available Upon Request. Boron Alloy Shackle Only.

**B555A\*/B555B**  
55mm Wide Solid Brass, Chrome Plated Body & 11mm Thick Hardened Steel Shackle. **B555A\*/B-2** - Optional 2" Shackle, Available Upon Request. Boron Alloy Shackle Only.

**B555M**  
55mm Wide Solid Brass Chrome Plated Body & 11mm Thick Hardened Steel Shackle

**B545A\*/B545B**  
45mm Wide Solid Brass, Chrome Plated Body & 9mm Thick Hardened Steel Shackle. **B545\*/B-2** - Optional 2" Shackle, Available Upon Request. Boron Alloy Shackle Only.

\* A = Hardened Steel Shackle  
B = Boron Alloy Shackle  
(Special order Item)



**S570D**  
70mm  
Disk Style  
Lock

**B571H**  
Replacement Cylinder Core for S570D (Sold Separately for Easy Re-Keying)



The 2570D can be easily re-keyed changing the old cylinder core and replacing it with a new cylinder core. Cylinders may be easily interchanged with other L.A.I. key ways.





**B532F**  
Switch Lock  
Two Flat Prongs  
Two Key Pulls  
Constant (On-Off)



**B533F**  
Switch Lock  
Two Flat Prongs  
One Key Pull  
Constant (On-Off)



**B536F**  
Switch Lock  
Two Flat Prongs  
Spring Loaded  
One Key Pull  
(Momentary)



**B534T**  
Switch Lock  
Four Round Prongs  
Three Key Pulls  
Constant (On-Off-On)





**B534H**  
Switch Lock  
Four Round Prongs  
One Key Pull  
Constant (On-Off-On)



**B532S**  
Switch Lock  
Screw Type Connectors  
Two Key Pulls  
Constant (On-Off)

**B536S**  
Switch Lock  
Screw Type Connectors  
One Key Pull  
(Momentary)



**S505K**  
Reset Key - All of Lock  
America's Re-Settable Locks  
have the ability to be  
"Re-combinated" with a  
special reset Key.



**B537H**  
7/8 inch / 22mm  
Re-Settable Camlock  
1/4 Turn - Right  
& Left





**Color Keybows**  
Color keybows allow for fast and  
easy identification of S502K keys.

**B539H**  
Re-Settable Tubular  
Plug Lock for  
T-Handles  
(Meets N.A.M.A. Standards)



**B538B**  
1-1/8 inch / 30mm  
Re-Settable Camlock  
1/4 Turn - Right  
& Left

Most Lock America  
T-Handles are equipped with  
Hardened Steel anti-drill roll pins  
to protect against drilling.



C865H-360

C865G-360  
T-Handle Screw Type  
*(Meets N.A.M.A. Specifications)*  
*\*\*Shaft is sold separately & please specify length\*\**



C865H-090

C865H-090  
T-Handle Quarter Turn  
*(Meets N.A.M.A. Specifications)*



C832H-090

C865H-090  
T-Handle Quarter Turn  
(Short Model 1 1/16")



C832H-090-BLK

C832H-090-BLK  
T-Handle Quarter Turn  
(Short Model 1 1/16") **\*\*Black\*\***

T-Handle  
Locks





S869H - Hasp Set  
 With Shroud Protection  
 Designed to fit Lock America's Millennium  
 Style Padlocks. See the LAI 600 Series Catalog.



BFL-6-46 - Hardened  
 Steel Hasp Set  
 See LAI 600 Series Catalog



Made to be used  
 with "A" Style Locks Only.



S820T - Hasp Set  
 (special application)

Accommodates all 500 and 600 Series LAI  
 Padlocks. See page 3 of this catalog or  
 LAI Series 600 catalog.





S868H-BL - Hasp Set  
Designed for use with  
all 500 and 600 series LAI padlocks.

S868H-MH  
Mounting Hardware - \*Sold Separate

S868H-CC  
Hardened Steel Carriage  
Bolt Cover - \*Sold Separate

**Di erent Profiles to Accommodate  
Most Manufacturers**  
*Please specify machine type*

S868R

S868H

S868D

S868H-PC - Hasp Set  
With Padlock Cover  
For use with shackle type  
padlocks. Designed for use  
with 500 and 600 series LAI Padlocks.

\*\*Made to use with Shackle style Padlocks

High Security  
Hasps





Welded Top Cover to help prevent bending.

Shrouded to protect padlock shackles from bolt cutter attacks.

Center Hole for use with Lock America's "F" model Millennium Locks.



S820T-A535 - Steel Hasp Set Shown with LAI Millennium Lock.

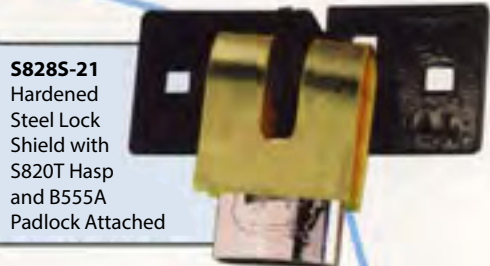

S828S-21 Hardened Steel Lock Shield with S820T Hasp and B555A Padlock Attached

S828S-28 Hardened Steel Lock Shield



S828S-21 Hardened Steel Lock Shield

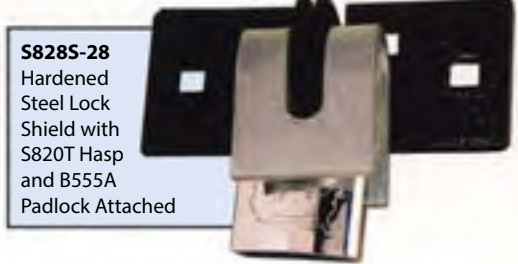

S828S-28 Hardened Steel Lock Shield with S820T Hasp and B555A Padlock Attached

S840T - BLK Steel Hasp Set (Black) For use with shackle type or discus style padlocks. See page 3 of this catalog or LAI 600 Series catalog.



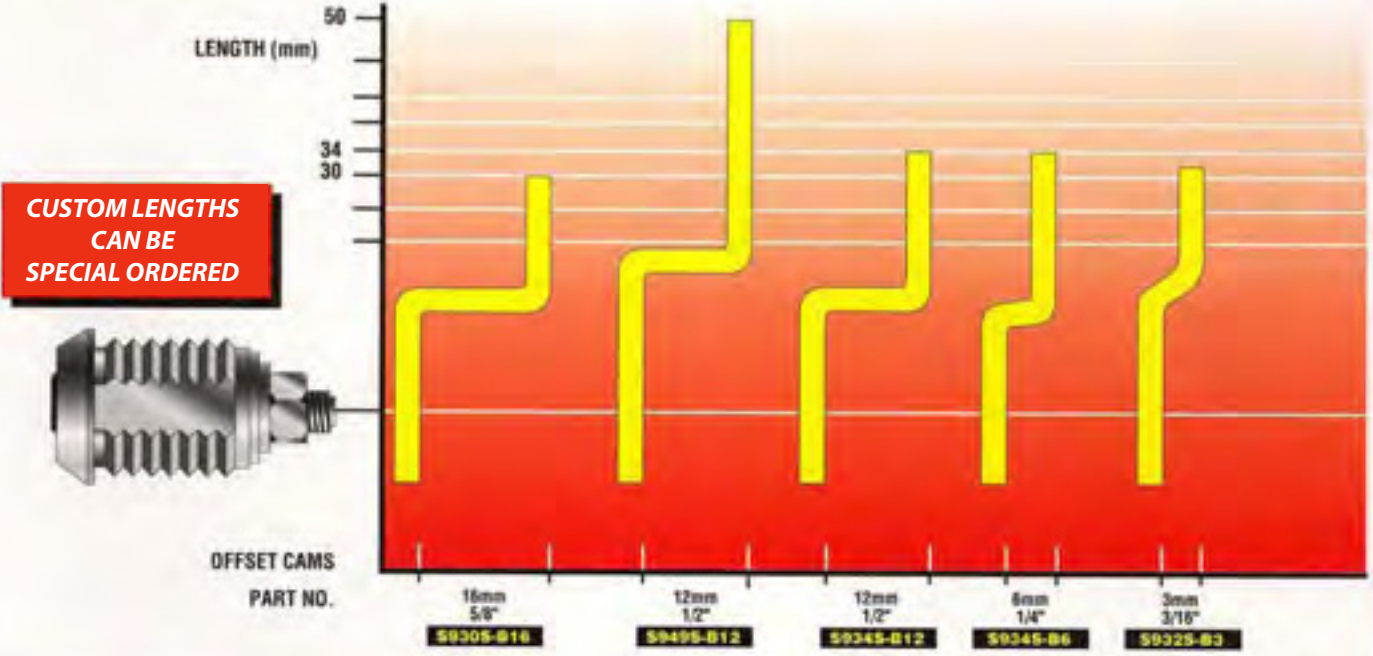

PART NO.	OUTER DIAMETER	INNER DIAMETER	HEIGHT	FLARS	MATERIAL	FINISH
S8215	1-1/8"	3/4"	1/8"	2	Steel	Nickel
S8235	1-1/16"	3/4"	1/8"	0	Steel	Nickel
S8245	7/8"	3/4"	1/8"	0	Steel	Nickel
S8225	1-1/8"	3/4"	1-1/16"	2	Steel	Nickel
S8255-H5	1-3/16"	3/4"	1/4"	0	Hardened Steel	Chrome
S8265	1-3/16"	3/4"	3/8"	0	Brass	Chrome

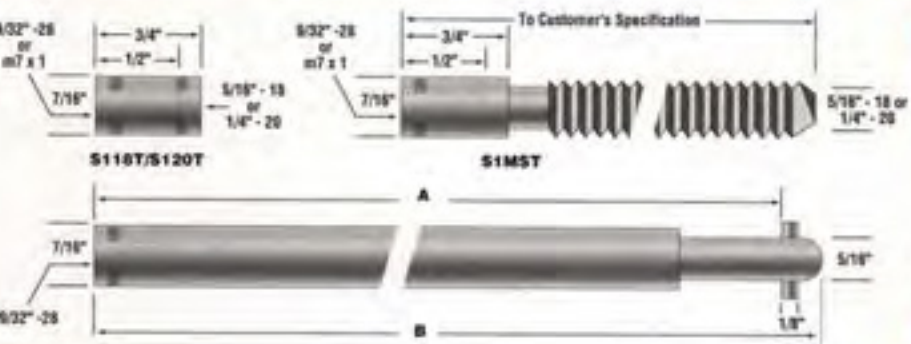

PART NO.	"A" DIMENSION	"B" DIMENSION
S112T	4-3/4"	5"
S121T	8-3/16"	8-7/16"
S130T	11-1/2"	11-5/8"
(See Insert)	12-5/16"	13-5/8"

Shaft can be used for both lengths.





